

ANTIGUA A
ART. NR. 443194
1/7

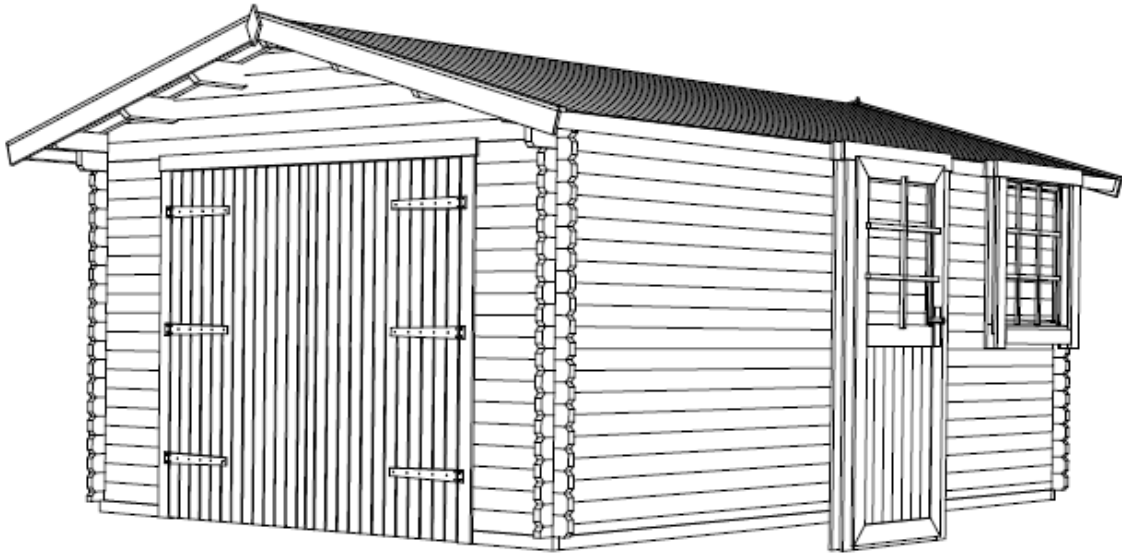

GRUNDPLAN - GRUNDPLAN - PLAN DE MASSE

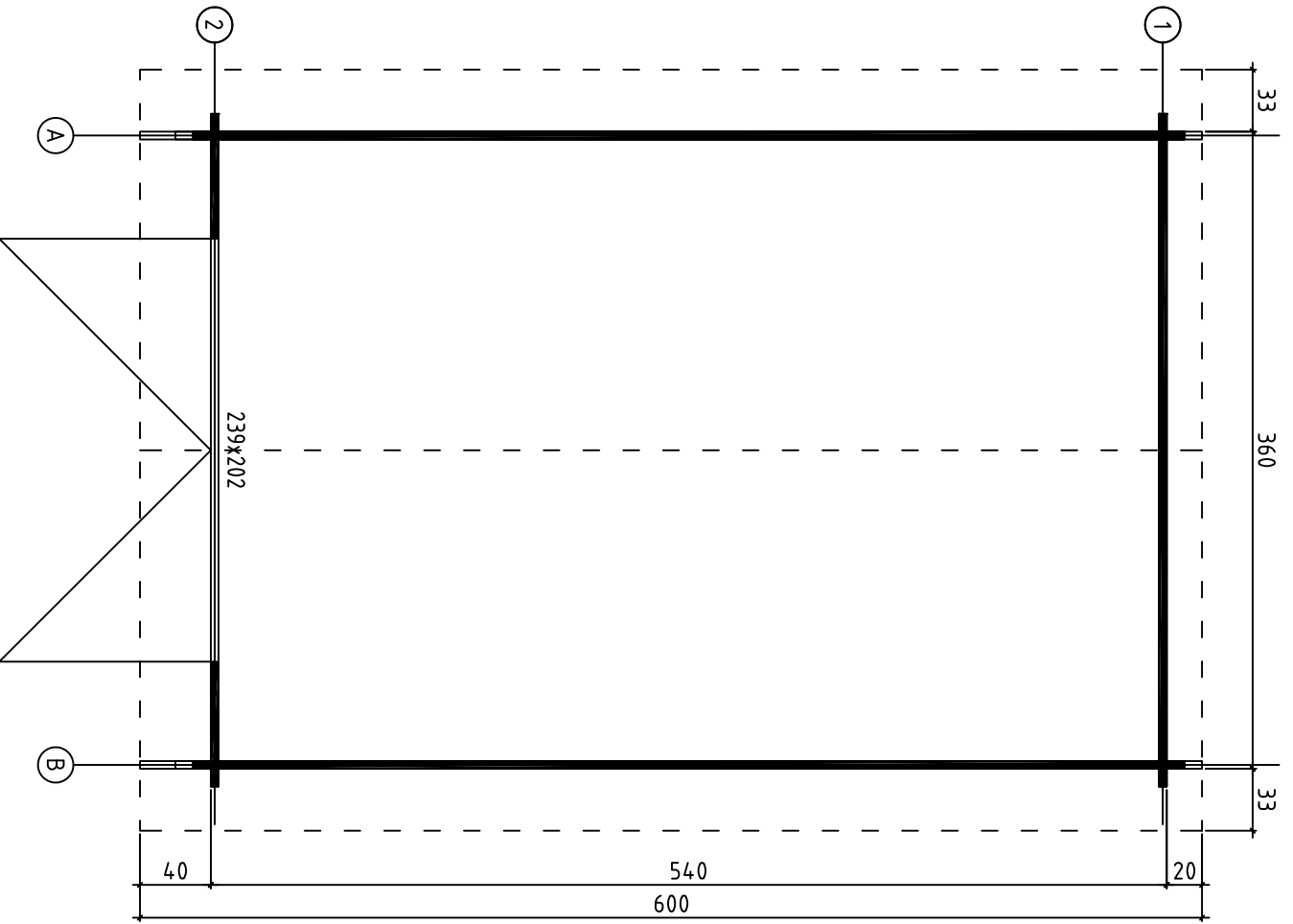

FOUNDATION - FUNDAMENT - FONDATION

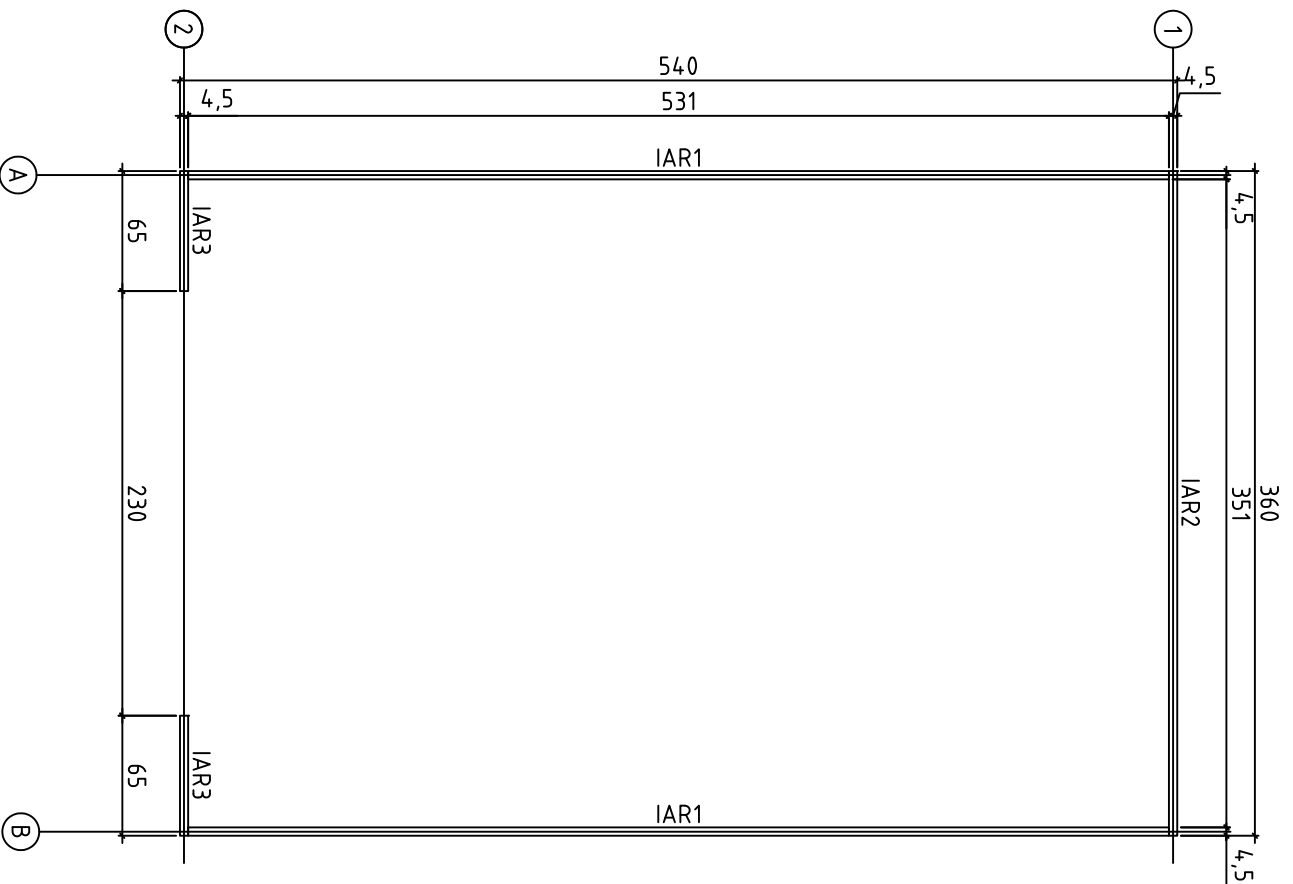

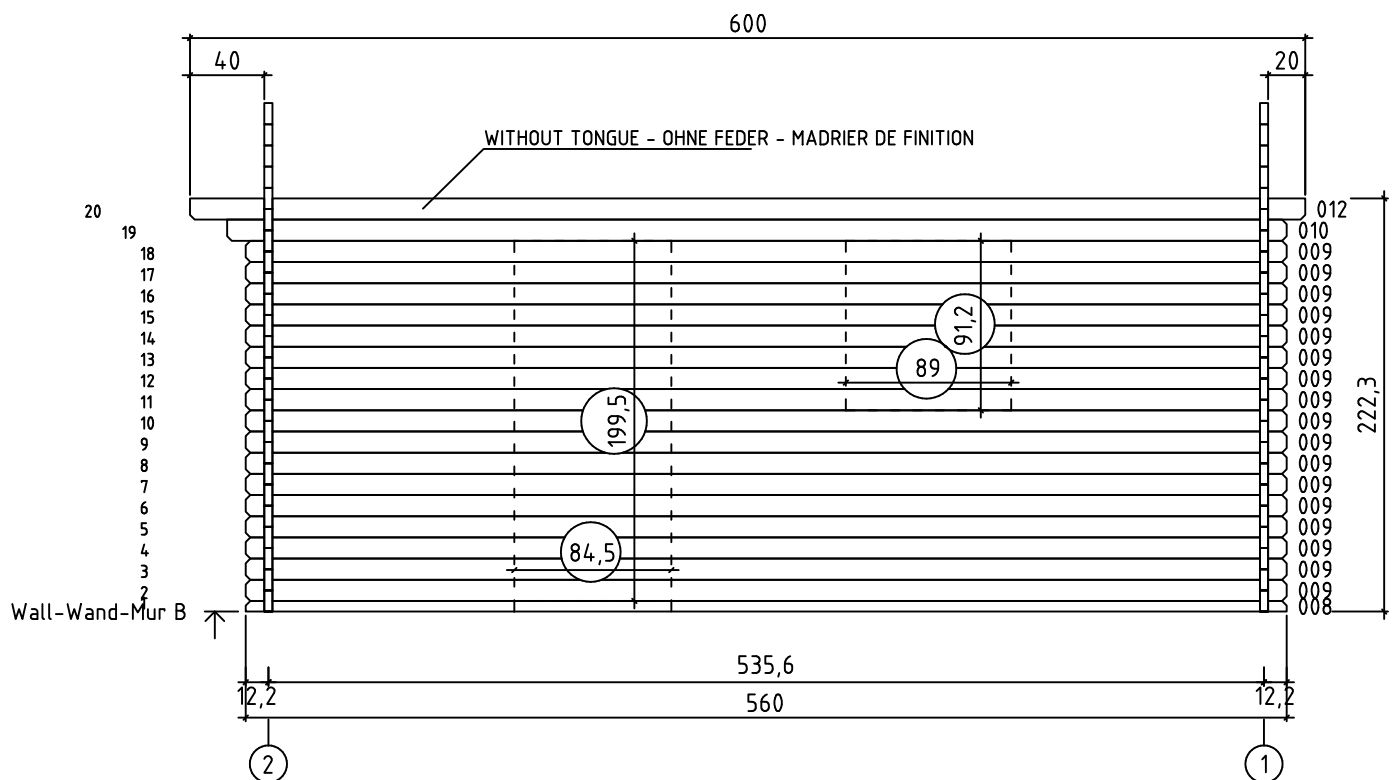
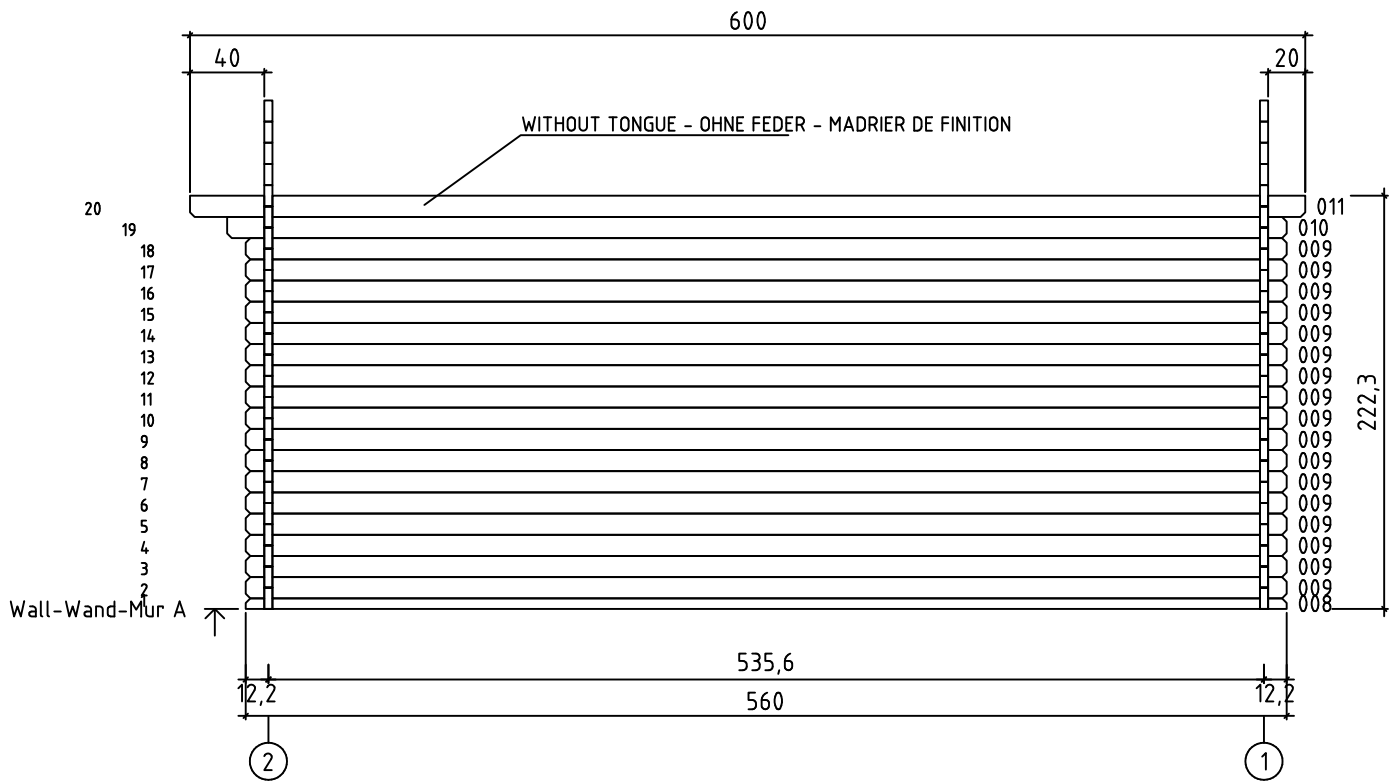







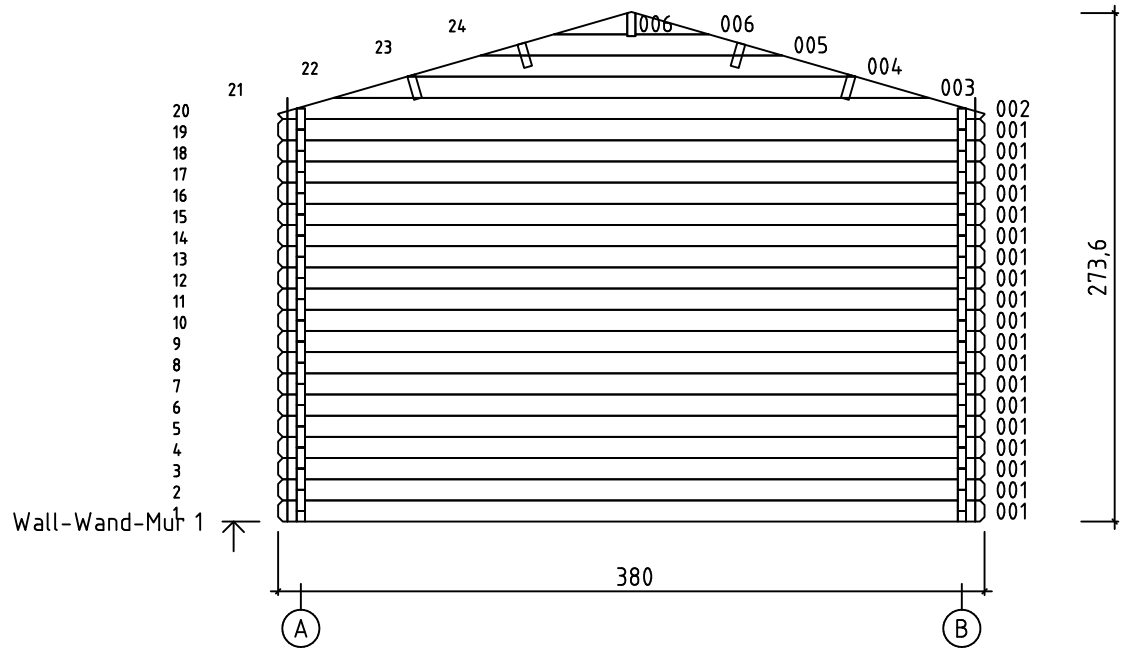
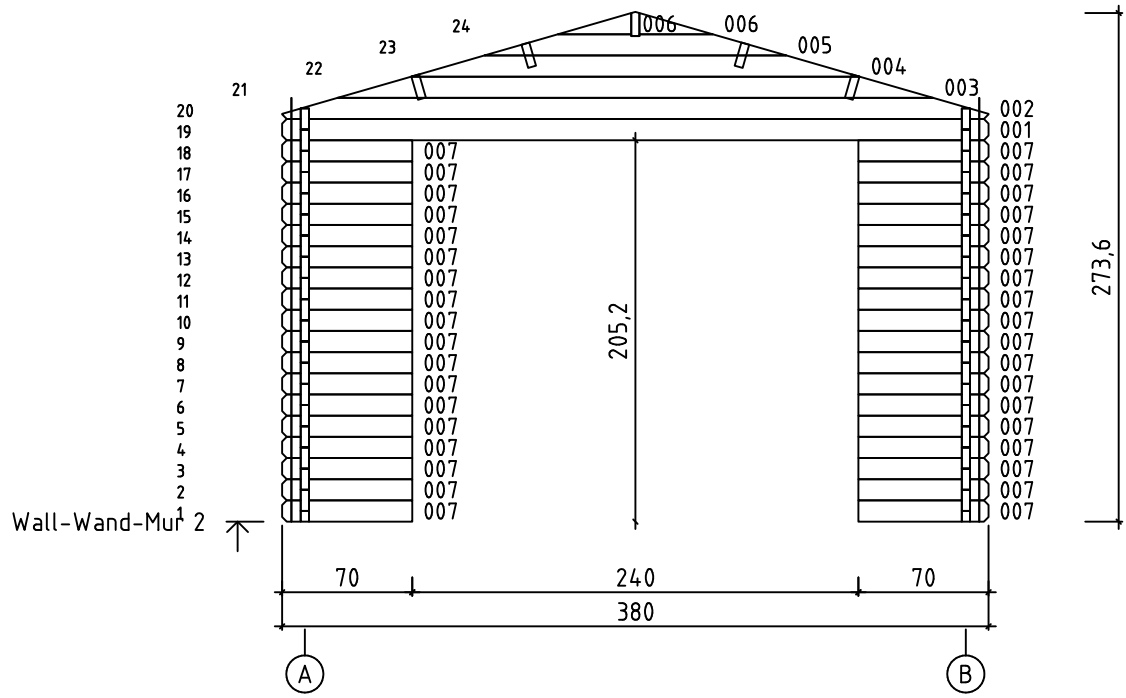

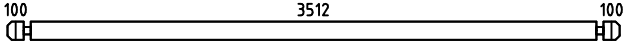
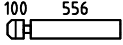
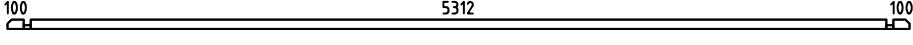
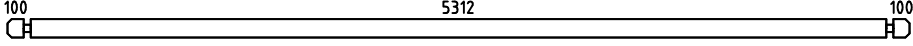
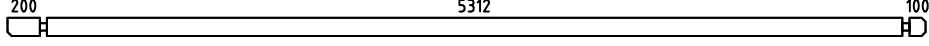
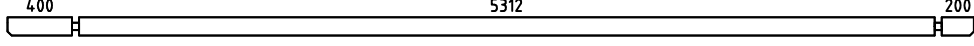
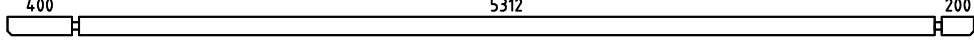
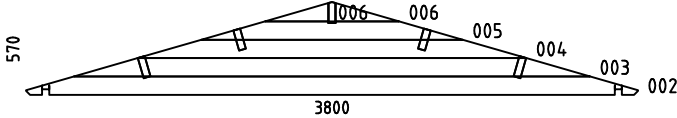
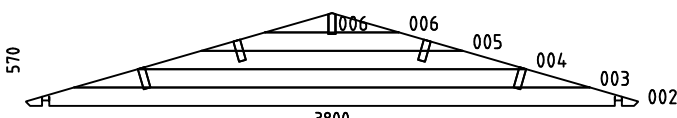
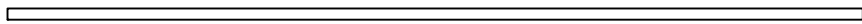
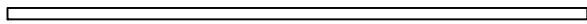
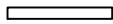
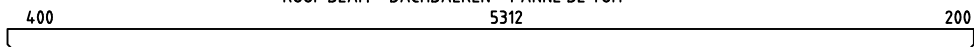
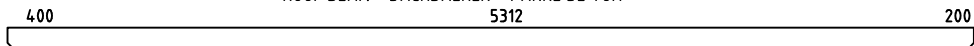



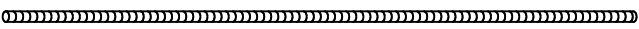

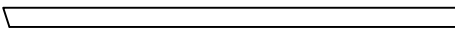







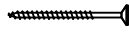
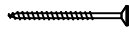
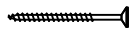
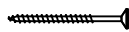
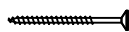
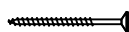
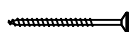

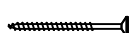
A SINGLE DOOR (83.5 X 195.7 CM) HAS BEEN DELIVERED TOGETHER WITH THE BUILDING. YOU CAN CHOOSE THE LOCATION FOR THE DOOR BY YOURSELF BY CUTTING THE WALL LOGS AS SHOWN IN THE PICTURE (SEE THE DOTTED LINE) THE DOOR BY YOURSELF BY CUTTING THE WALL LOGS AS SHOWN IN THE PICTURE (SEE THE DOTTED LINE)





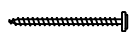
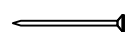
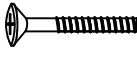
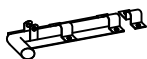

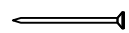
IM LIEFERUMFANG IST EINE EINZEL TÜR SOWIE EIN EINZELFENSTER ENTHALTEN. DAFÜR SIND ABER WERKSSEITIG KEINE AUSSPARUNGEN VORGESEHEN SO DASS SIE SOWOHL FENSTER ALS AUCH TÜR INDIVIDUELL VERBAUEN KÖNNEN. EINE ANLEITUNG HIERFÜR ENTNEHMEN SIE BITTE DER MONTAGE-ANLEITUNG (SIEHE BILD)

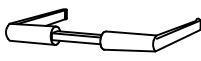
LE POSITIONNEMENT DE LA PORTE DE SERVICE NÉCESSITE LA DÉCOUPE PRÉALABLE DES MADRIERS. VEILLEZ RESPECTER LES COTES DE DÉCOUPES DANS LES MADRIERS INDICUÉES SUR LE SCHÉMA. VOUS POUVEZ POSITIONNER, SELON VOTRE CONVENANCE, LES OUVERTURES DE CHAQUE CÔTÉ OU À L'ARRIÈRE DU GARAGE.

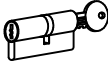

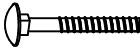
Pos	16.11.2010	ART.NR. 443194	5/7	Q.	P (mm)	L (mm)
001				20	44x114	3800
007				36	44x114	700
008				2	44x57	5600
009				34	44x114	5600
010				2	44x114	5700
011				1	44x120	6000
012				1	44x120	6000
W1-1				1		
W2-1				1		
IAR1	FOUNDATION - FUNDAMENT - FONDATION 			2	45x70	5310
IAR2	FOUNDATION - FUNDAMENT - FONDATION 			1	45x70	3600
IAR3	FOUNDATION - FUNDAMENT - FONDATION 			2	45x70	650
PPR1	ROOF BEAM - DACHBALKEN - PANNE DE TOIT 			1	44x140	6000
APR1	ROOF BEAM - DACHBALKEN - PANNE DE TOIT 			4	44x140	6000
	ROOF BOARDS - DACHBRETTER - VOLIGES 			134	90x18	2200
	ROOFING FELT FILLET - DACHPAPPENLEISTE - BAGUETTE DE FIXATION DU FEUTRE BITUMEUX 			4	18x58	2250
	TREADED ROD M10 - GEWINDESTANGE M10 - TIGE FILETÉE M10 			4		230
	TREADED ROD M10 - GEWINDESTANGE M10 TIGE FILETÉE M10 			4		2000
	EAVES BOARD - TRAUFBRETT - BANDEAU DE TOIT 			4	18x90	3000
	ROOF EDGE REINFORCEMENT - DACHRANDVERSTÄRKUNG - CORNIERE DE RENFORT DE BORD DE TOIT 			4	28x34	3000
	GABLE MOULDING - GIBELLEISTE PLANCHE DE RIVE 			4	18x120	2250
	WINDOW HANDLE FITTINGS-FENSTERGRIFF - POIGNÉE D'OUVERTURE DE FENETRE 			1		
	LENGTHENING BOLT FOR TREADED ROD -VERLÄNGERUNGSMUTTER FÜR GEWINDESTANGE - MANCHON DE RACCORDEMENT DE TIGE FILETÉE 			4		

Pos	16.11.2010	ART.NR. 443194	6/7	Q.	P (mm)	L (mm)
	DRIVE NUT TREADED ROD - EINSHLAGMUTTER FÜR GEWINDESTANGE - ÉCROU A FRAPPER POUR TIGE FILETÉE			4		
	NUT FOR TREADED ROD - MUTTER FÜR GEWINDESTANGE - ÉCROU POUR TIGE FILETÉE			4		
	PLAIN WASHER TREADED ROD - UNTERLEGSSCHEIBE FÜR GEWINDESTANGE - RONDELLE PLATE POUR TIGE FILETÉE			4		
	SCREW FOR LATCH BOLT FOR GATE - SCHRAUBE FÜR DOPPELTÜR-FESTSTELLRIEGEL - VIS DE FIXATION DE LA SERRURE DE PORTE			8	3.5x20	
	SCREW FOR GABLE SEGMENT - SCHRAUBEN FÜR DECKBLATT - VIS POUR FIXATION LOSANGE DE FINITION			4	3.5x35	
	SCREW FOR FIXING DOOR TO THE WALL - SCHRAUBE ZUR BEFESTIGUNG TÜR- ZARGE MIT WAND - VIS DE FIXATION DORMANT DE PORTE			4	3.5x50	
	SCREW FOR GABLE MOULDING - SCHRAUBEN FÜR GIEBELLEISTE - VIS DE FIXATION POUR PLANCHE DE RIVE			32	3.5x50	
	SCREW FOR DOOR FILLET - SCHRAUBE ZUR BEFESTIGUNG TÜRLEISTE - VIS D'ASSEMBLAGE DU CADRE DE PORTE			6	3x30	
	SCREW FOR LATCH BOLT FOR GATE - SCHRAUBE FÜR DOPPELTÜR-FESTSTELLRIEGEL - VIS DE FIXATION DE LA SERRURE DE PORTE			6	4x40	
	SCREW FOR EAVES BOARDS - SCHRAUBEN FÜR TRAUFBRETT - VIS DE FIXATION POUR BANDEAU DE TOIT			28	4x40	
	SCREW FOR ROOF EDGE REINFORCEMENT - SCHRAUBEN FÜR DACHRANDVERSTÄRKUNG - VIS POUR RENFORT DE BORD DE TOIT			28	4x40	
	SCREW FOR ROOF BEAMS - SCHRAUBEN FÜR DACHBALKEN - VIS POUR PANNE DE TOIT			14	5x120	
	SCREW FOR 1. WALL BEAM - SCHRAUBE FÜR 1. BOHLENREIHE - VIS DE FIXATION DES FONDATIONS			8	5x90	
	SCREW FOR FUNDAMENT - SCHRAUBEN ZUR BEFESTIGUNG FUNDAMENT - VIS POUR FONDATION			4	5x90	
	SCREW FOR DOOR JAMB - SCHRAUBE FÜR TÜRRAHMEN - VIS DE FIXATION POUR MONTANT DE PORTE			2	5x90	
	SCREW FOR GATE HINGES - SCHRAUBEN FÜR TORRIEGEL - VIS POUR LES CHARNIERES DE PORTE			54	6x40	
	HAMMER BLOCK - SCHLAGHOLZ - CALLE DE FRAPPE			1		
	SCREW FOR DOORSTEP - SCHRAUBEN FÜR TÜRSWELLE - VIS DE FIXATION DU SEUIL DE PORTE			2	4.5x65	
	ZN NAIL FOR ROOFING FELT FILLET - ZN NÄGEL FÜR DACHPAPPENLEISTE - POINTE POUR BAGUETTE FIXATION FEUTRE BITUMEUX			20	2x40	
	BOLT FOR WINDOW HANDLE FITTINGS - BOLZEN FÜR FENSTERGRIFF BESCHLAG - BOULON POUR POIGNÉE D'OUVERTURE DE FENETRE			2		
	LATCH BOLT FÜR DOUBLE DOOR - TORRIEGEL - LOQUET POUR DOUBLE PORTE			3		
	GABLE SEGMENT-DECKBLATT - LOSANGE DE FINITION			2		
	ZN NAIL FOR ROOF - ZN NÄGEL FÜR DACHBRETT - POINTE POUR TOIT			550	2x50	
	DOOR HANDLE FITTINGS-TÜRGRIF - SET DE GARNITURES DE SERRURE DE PORTE			1		
	DOOR HANDLE FITTINGS-TÜRGRIF - SET DE GARNITURES DE SERRURE DE PORTE			1		

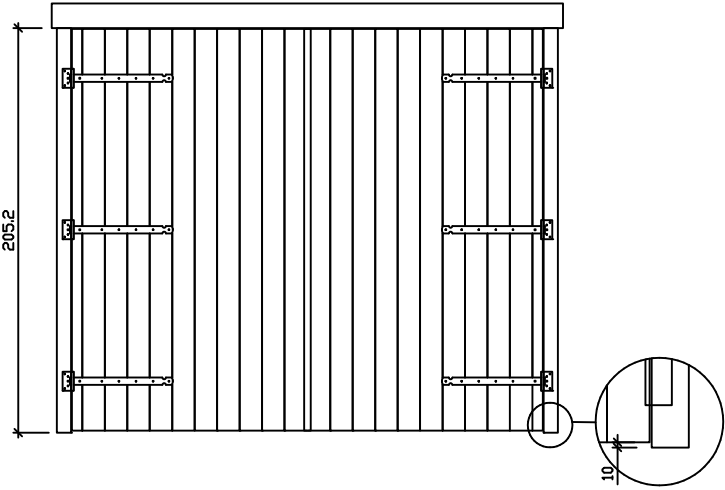
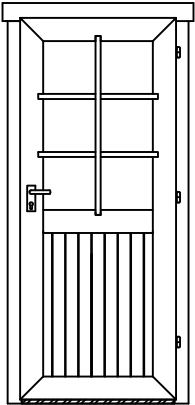
Pos	16.11.2010	ART.NR. 443194	7/7	Q.	P (mm)	L (mm)
	CYLINDER -ZYLINDERSCHLOSS - CYLINDRE DE SERRURE			1		
	GATE HINGES - TORRIEGEL - CHARNIERES DE PORTE			12		
	BOLT FOR GATE HINGES - BOLZEN FÜR TORRIEGEL - BOULON POUR LES CHARNIERES DE PORTE			6		
	BOLT FOR GATE HINGES - BOLZEN FÜR TORRIEGEL - BOULON POUR LES CHARNIERES DE PORTE			6		
	WASHER FOR GATE HINGES - DICHTSCHEIBE FÜR TORRIEGEL - RONDELLE POUR LES CHARNIERES DE PORTE			12		
	GATE HINGES - TORRIEGEL - CHARNIERES DE PORTE			6		
	WINDOW-FENSTER-FENETRE 882x882	AK.1.109.SSP.b		1		
	DOOR-TÜR-PORTE 2390x2020	TUL.2.100.IVP.TA		1		
	DOOR-TÜR-PORTE 835x1957	UK.2.056.SVP.MM		1		