

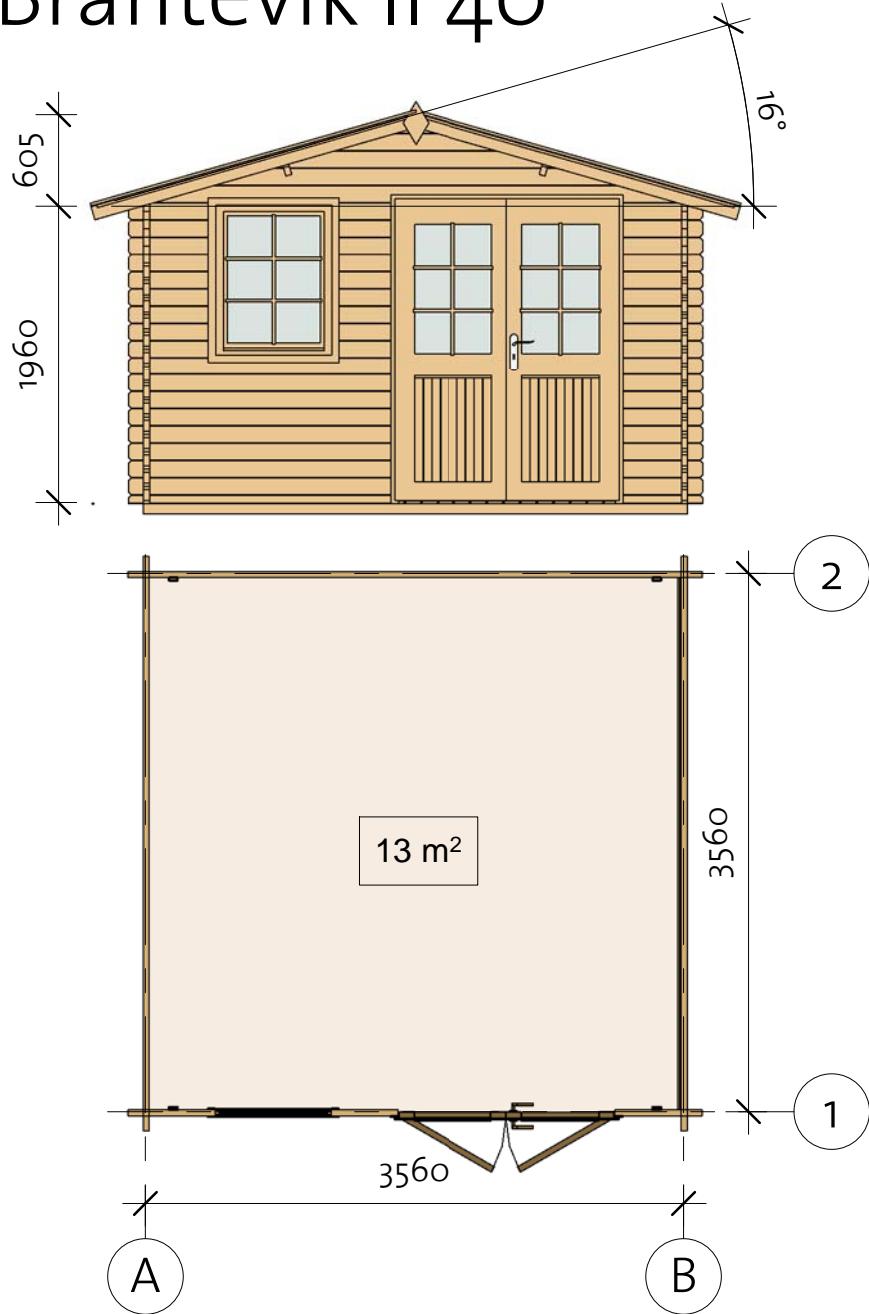

Brantevik II 40

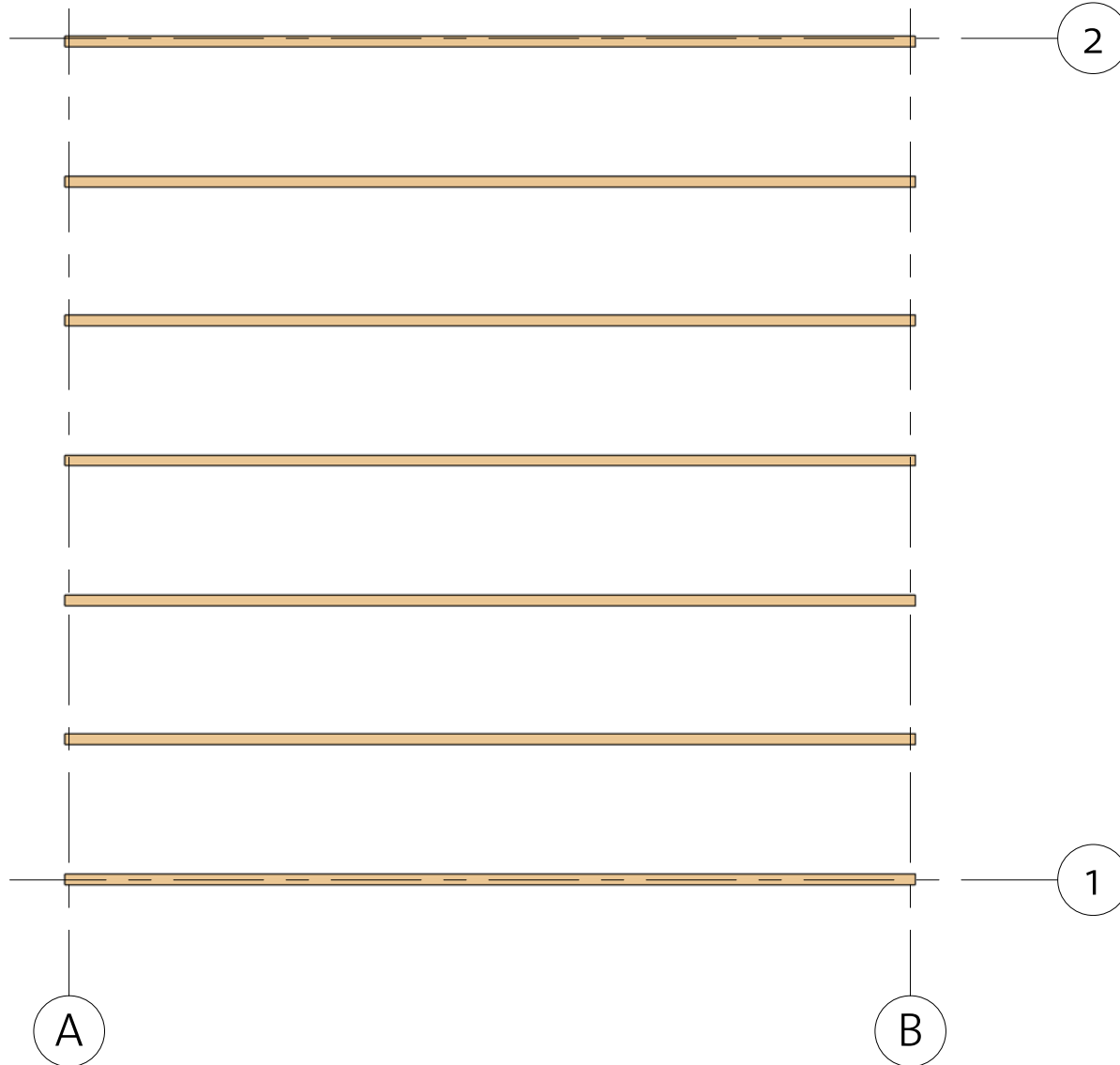

Brantevik II 40

Foundation





| Impregnated foundation beams | | | | |
|------------------------------|--------------|---|-------|--------|
| Mark | Type | Profile | Count | Length |
| IFB | IFB 45x70 |  | 7 | 3600 |

Brantevik II 40

Floor Plan

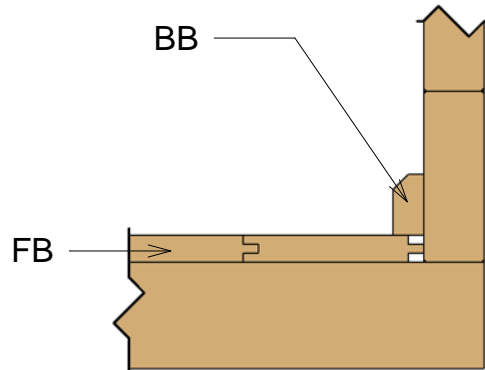
Ⓛ Baseboard



| Floor Schedule | | | | |
|----------------|-----------|---|-------|--------|
| Mark | Type | Profile | Count | Length |
| FB | FB 18x110 |  | 33 | 3515 |
| BB | BB 20x40 |  | -- | 14,1 m |

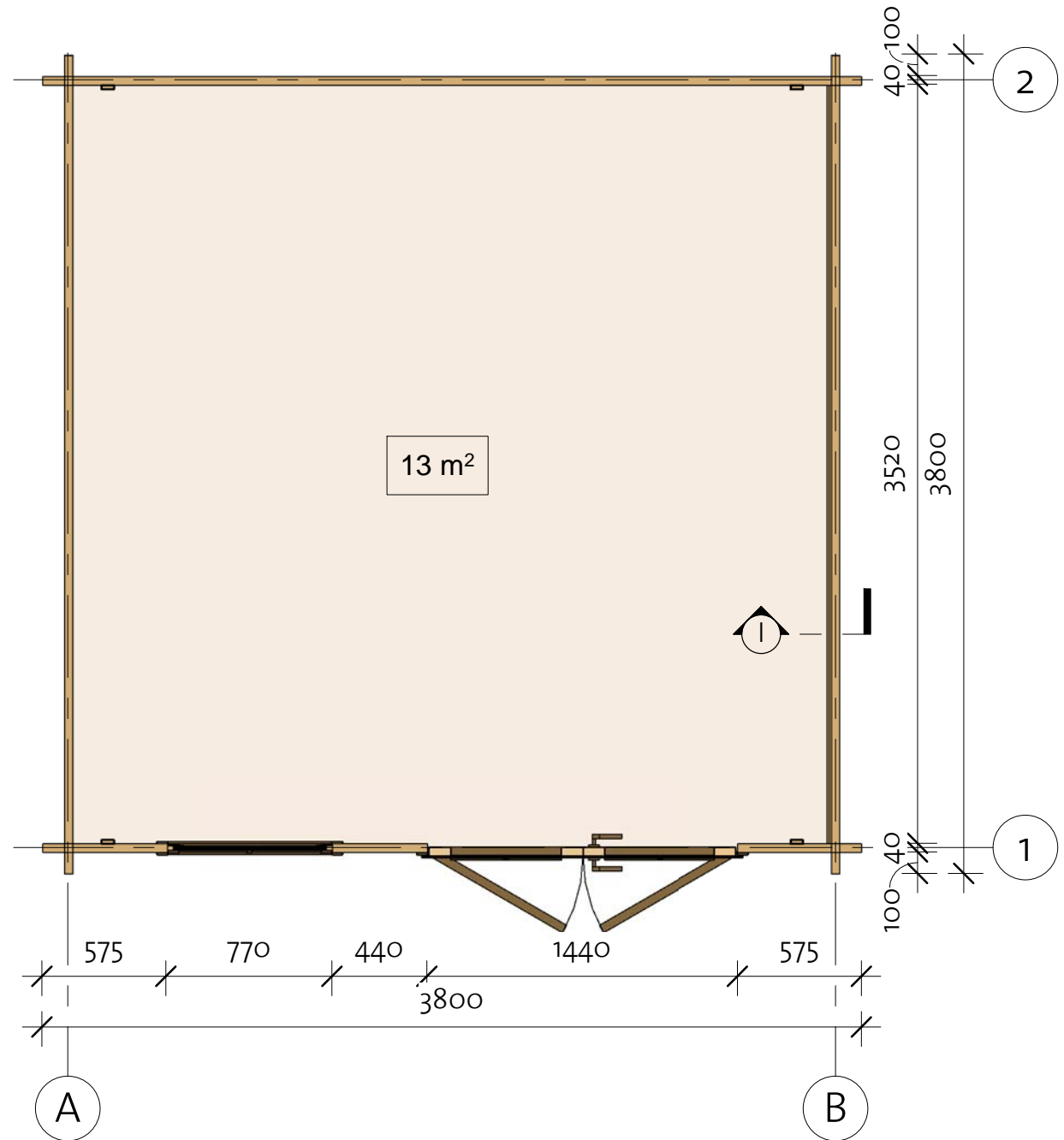

Brantevik II 40

Wall 1

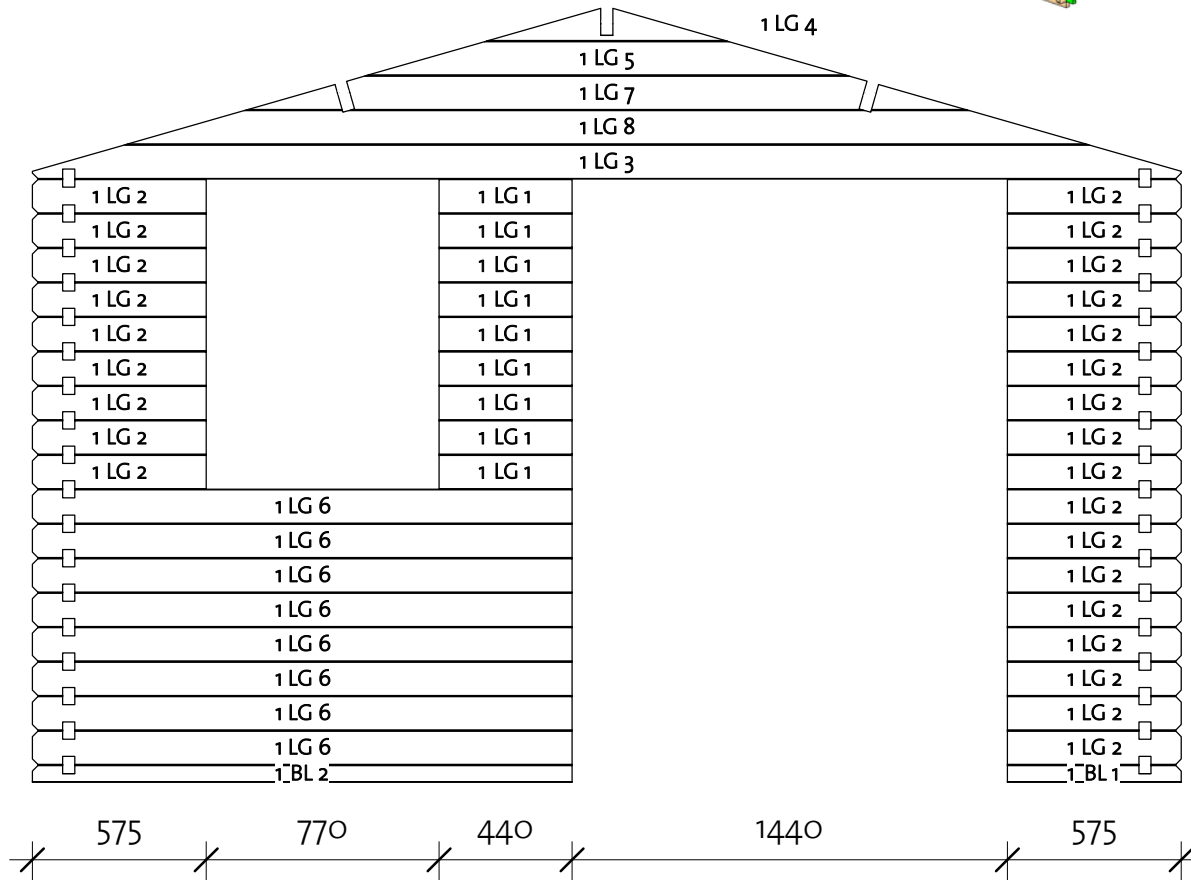
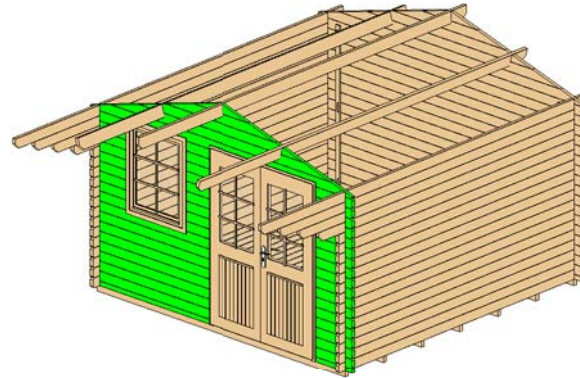

| Wall 1 | | | | |
|--------|-------------|---------|-------|------------|
| Mark | FM SortMark | Profile | Count | Cut Length |

| | | | | |
|--------|------|--------|----|------|
| 1BL 1 | BL 1 | 40X57 | 1 | 575 |
| 1BL 2 | BL 2 | 40X57 | 1 | 1785 |
| 1LG 1 | LG 1 | 40X114 | 9 | 440 |
| 1LG 2 | LG 2 | 40X114 | 26 | 575 |
| 1LG 3* | LG 3 | 40X114 | 1 | 3800 |
| 1LG 4* | LG 4 | 40X114 | 1 | 796 |
| 1LG 5* | LG 5 | 40X114 | 1 | 1591 |
| 1LG 6 | LG 6 | 40X114 | 8 | 1785 |
| 1LG 7* | LG 7 | 40X114 | 1 | 2386 |
| 1LG 8* | LG 8 | 40X114 | 1 | 3182 |

*Gable-delivered premounted

| Log Profile Wall 1 | |
|--------------------|---------|
| Profile | Profile |

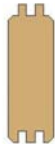
| | |
|--------|---|
| 40X57 |  |
| 40X114 |  |

Brantevik II 40

Wall 2

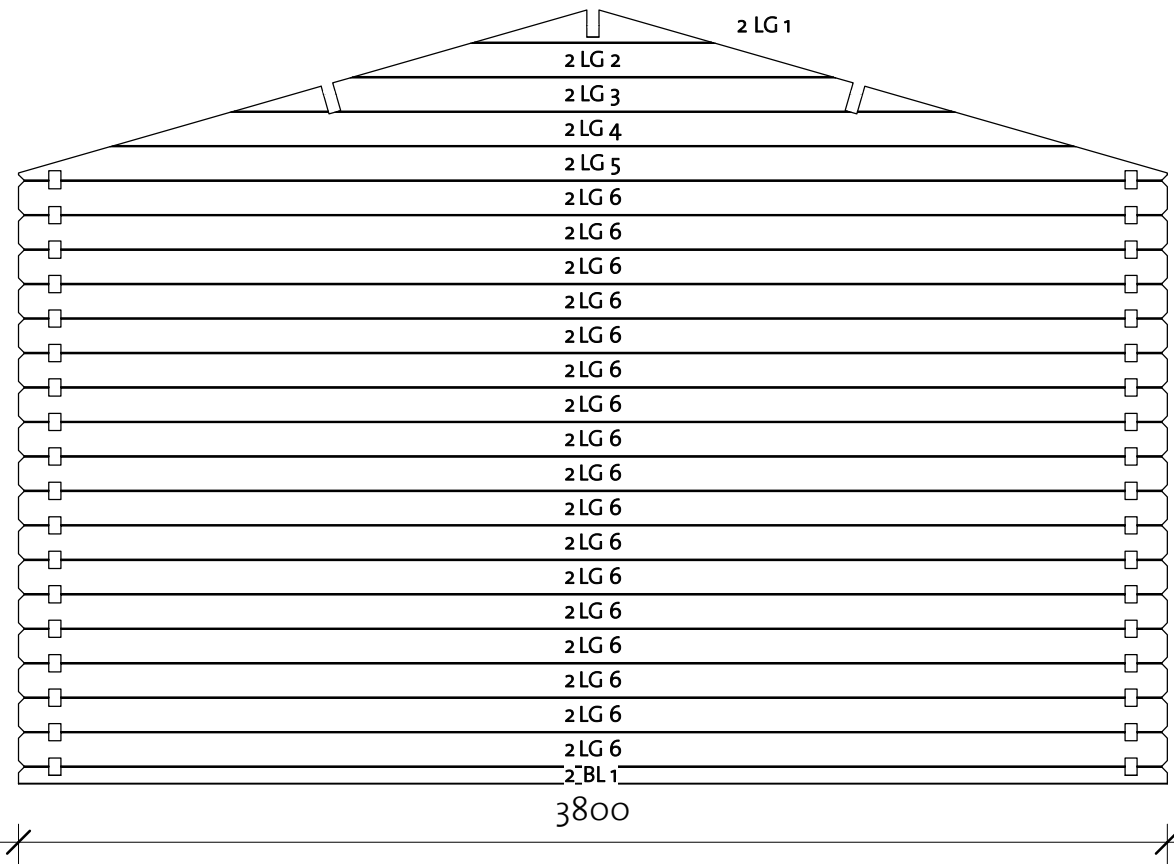
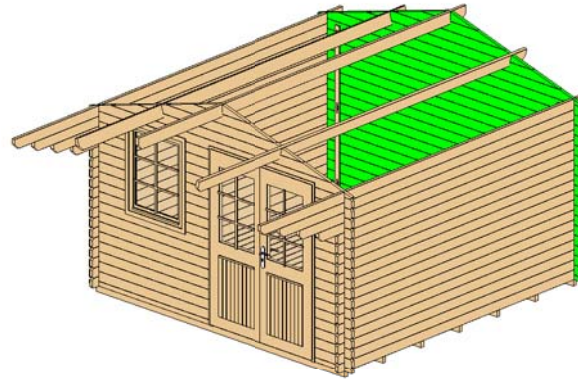

| Wall 2 | | | | |
|--------|-------------|---------|-------|------------|
| Mark | FM SortMark | Profile | Count | Cut Length |

| | | | | |
|--------|------|--------|----|------|
| 2BL 1 | BL 1 | 40X57 | 1 | 3800 |
| 2LG 1* | LG 1 | 40X114 | 1 | 796 |
| 2LG 2* | LG 2 | 40X114 | 1 | 1591 |
| 2LG 3* | LG 3 | 40X114 | 1 | 2386 |
| 2LG 4* | LG 4 | 40X114 | 1 | 3182 |
| 2LG 5* | LG 5 | 40X114 | 1 | 3800 |
| 2LG 6 | LG 6 | 40X114 | 17 | 3800 |

*Gable-delivered premounted

| Log Profile Wall 2 | |
|--------------------|---------|
| Profile | Profile |

| | |
|--------|--|
| 40X57 | |
| 40X114 | |

Brantevik II 40

Wall A

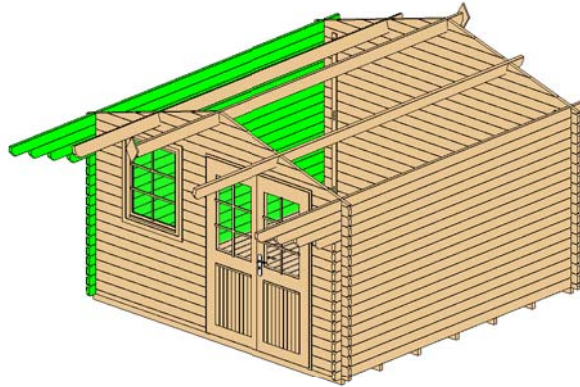

| Wall A | | | | |
|--------|-------------|---------|-------|------------|
| Mark | FM SortMark | Profile | Count | Cut Length |

| | | | | |
|-------|------|--------|----|------|
| ALG 1 | LG 1 | 40X114 | 14 | 3800 |
| ALG 2 | LG 2 | 40X114 | 1 | 4100 |
| ALG 3 | LG 3 | 40X114 | 1 | 4400 |
| ALG 4 | LG 4 | 40X114 | 1 | 4700 |
| ATL 1 | TL 1 | 40X120 | 1 | 5100 |

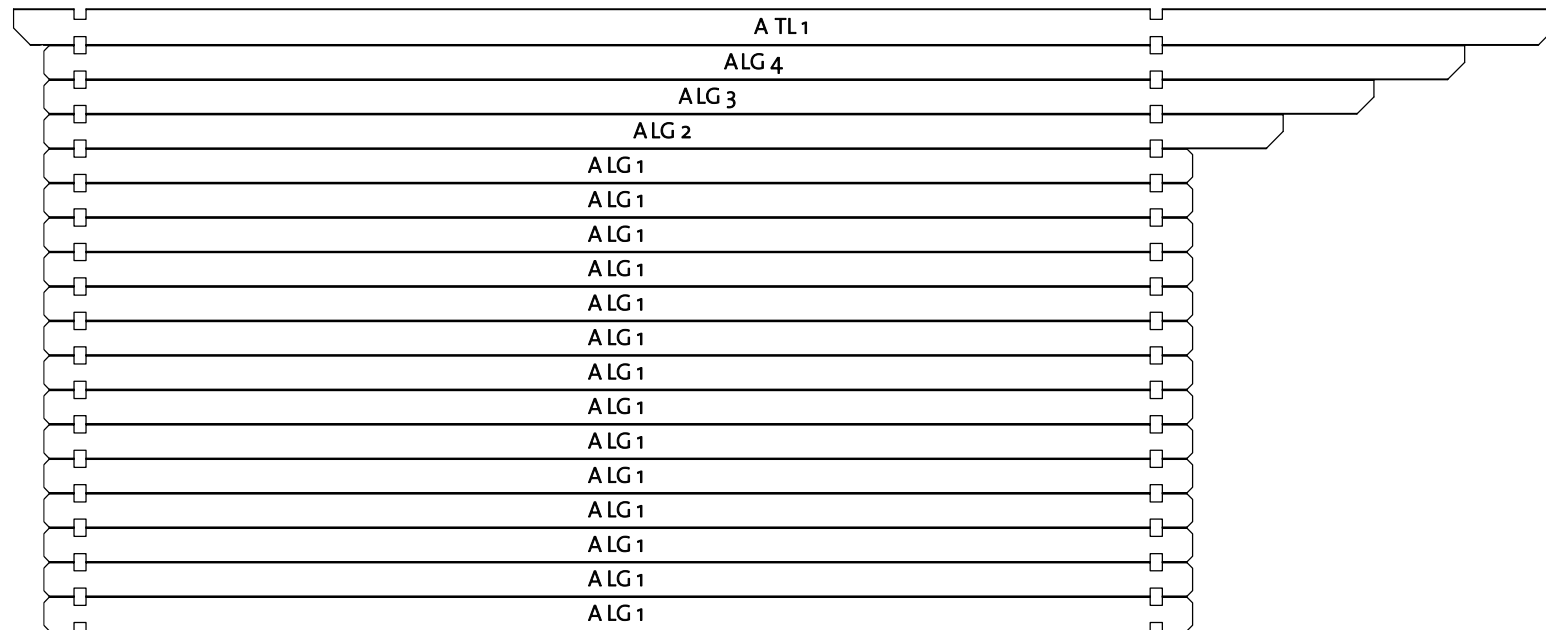

| Log Profile Wall A | |
|--------------------|---------|
| Profile | Profile |

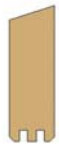
| | |
|--------|---|
| 40X114 |  |
| 40X120 |  |

Brantevik II 40

Wall B

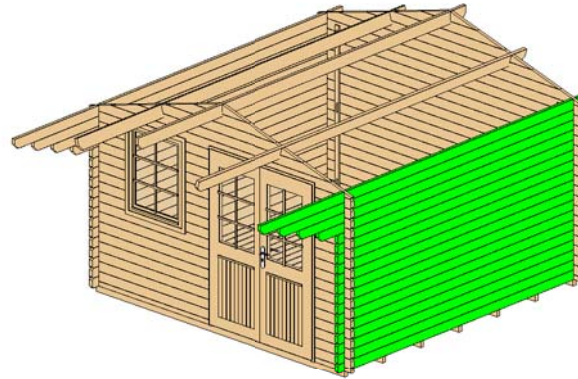

| Wall B | | | | |
|--------|-------------|---------|-------|------------|
| Mark | FM SortMark | Profile | Count | Cut Length |

| | | | | |
|-------|------|--------|----|------|
| BLG 1 | LG 1 | 40X114 | 14 | 3800 |
| BLG 2 | LG 2 | 40X114 | 1 | 4100 |
| BLG 3 | LG 3 | 40X114 | 1 | 4400 |
| BLG 4 | LG 4 | 40X114 | 1 | 4700 |
| BTL 1 | TL 1 | 40X120 | 1 | 5100 |

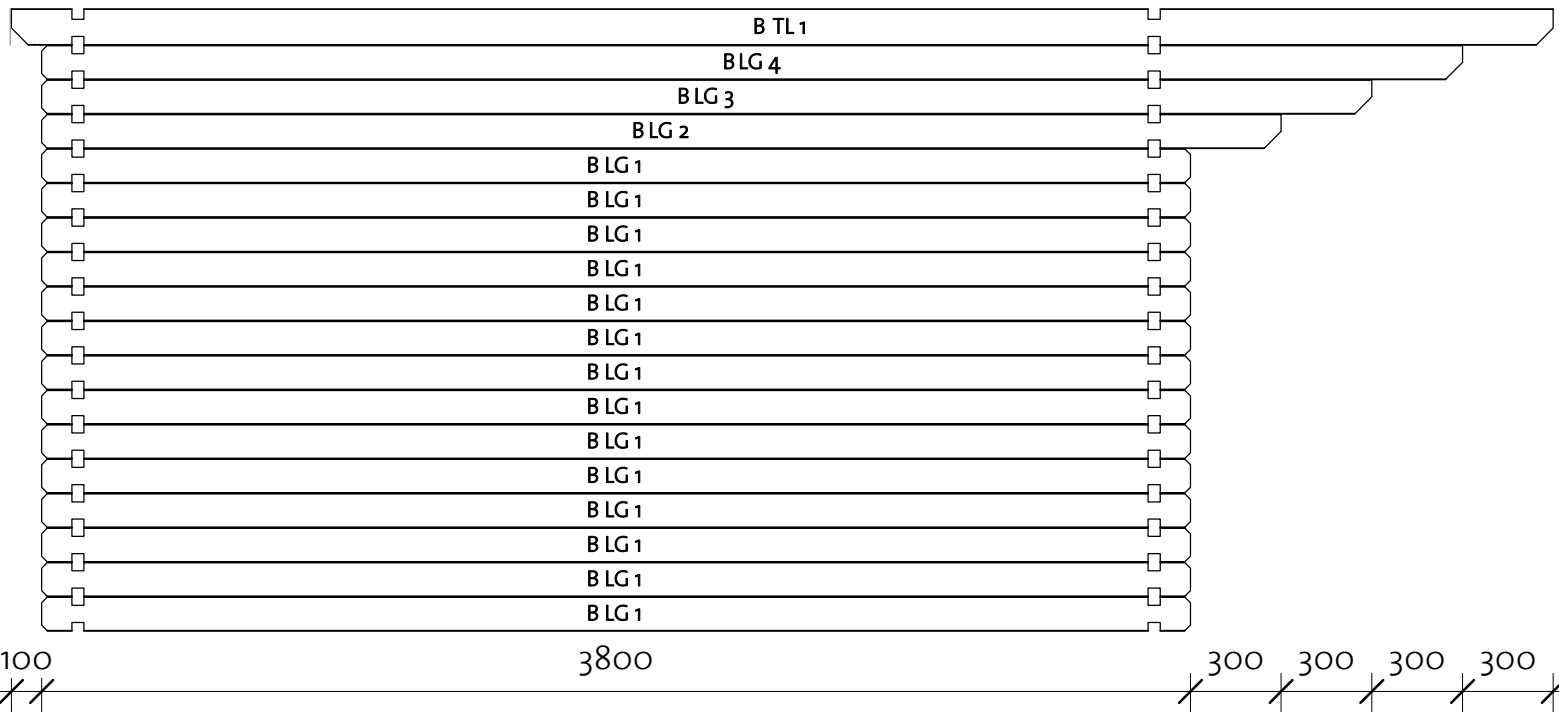





| Log Profile Wall B | |
|--------------------|---------|
| Profile | Profile |

| | |
|--------|--|
| 40X114 | |
| 40X120 | |

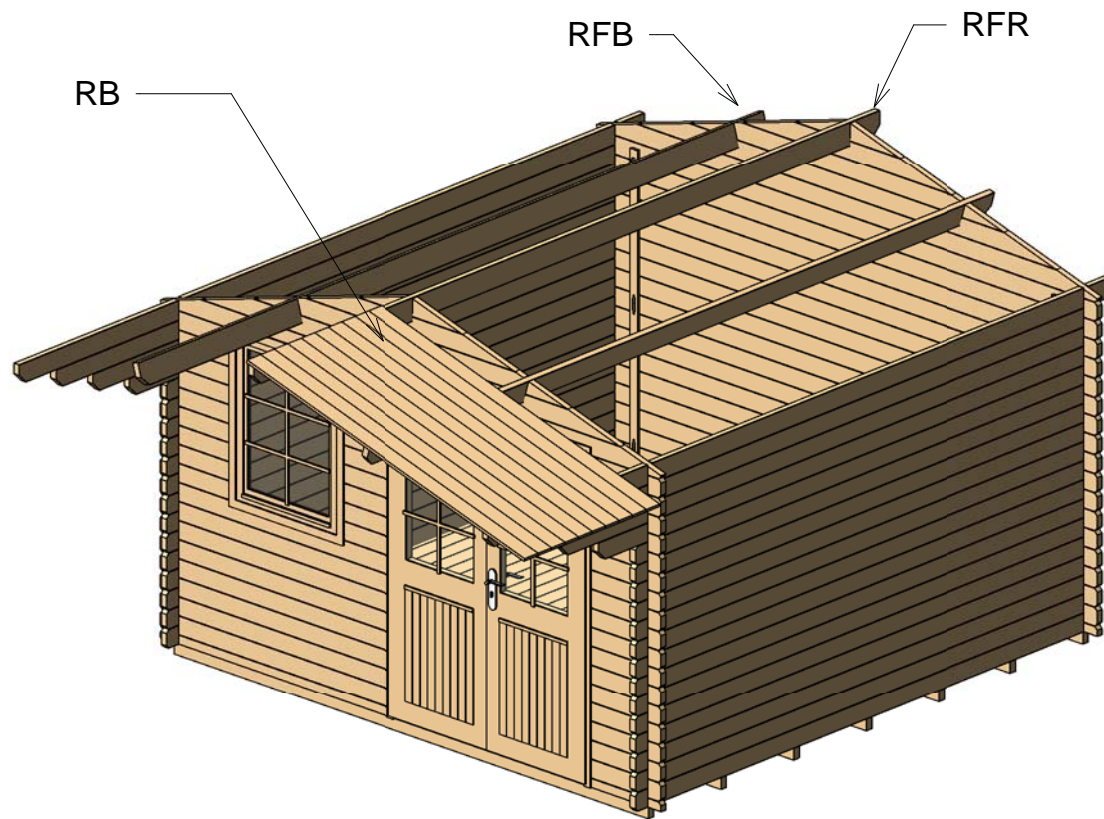
Brantevik II 40

Roof 1



| Roof | | | | |
|------|---------------------|---|-------|--------|
| Mark | Type | Profile | Count | Length |
| RFR | Ridge 40x143 |  | 1 | 5100 |
| RFB | Beam 40x143 |  | 2 | 5100 |
| RB | Roofboard 18x110 |  | 94 | 2195 |

Brantevik II 40

Roof 2

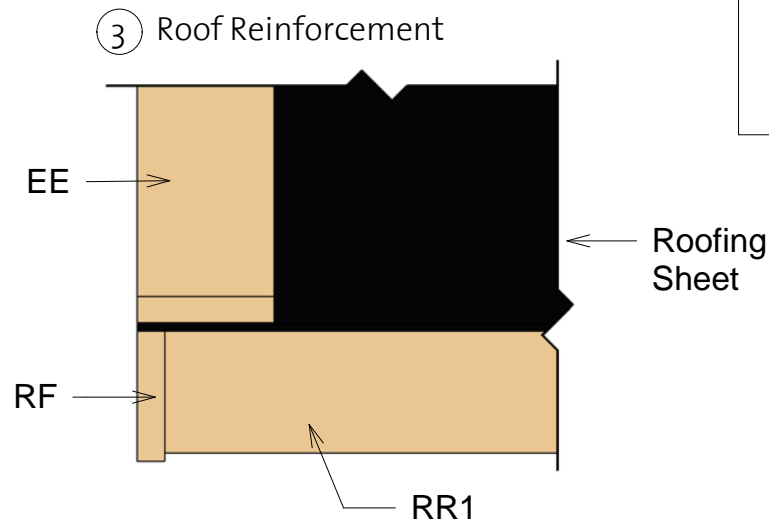
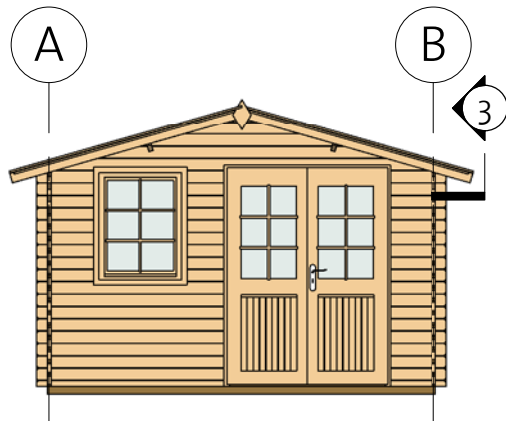
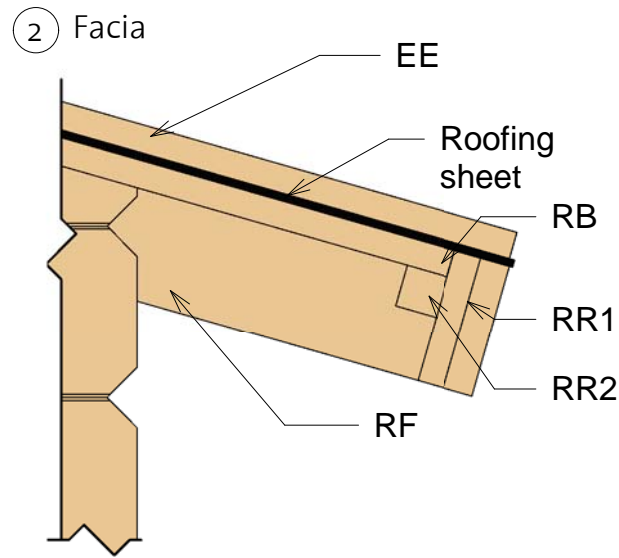
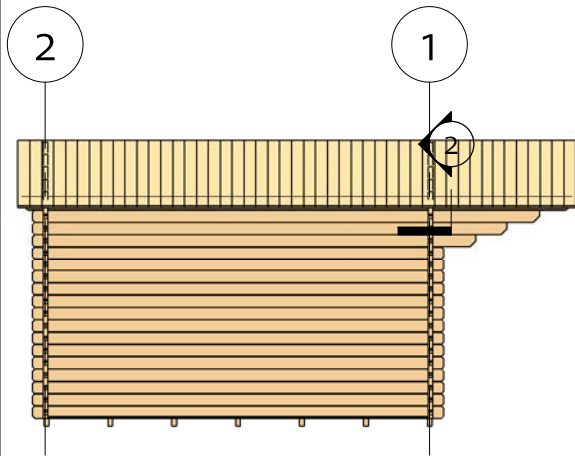

| Fascia Schedule | | | | |
|-----------------|--------------------------------|---------|-------|--------|
| Mark | Type | Profile | Count | Length |
| EE | Eave Edging 18x90 | | 4 | 2233 |
| RF | Roof Fascia 18x90 | | 4 | 2233 |
| RR1 | Roof reinforcement 18x90 | | 2 | 5100 |
| RR2 | Roof reinforcement 28x28 | | 4 | 2550 |

Brantevik II 40

Extras

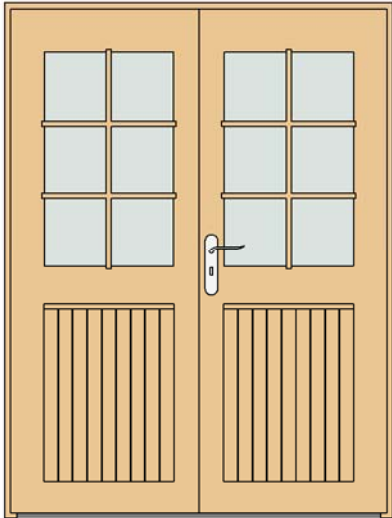

| Door Schedule | | | | |
|---------------|---------------------|-------|--------|-------|
| Mark | Type | Width | Height | Count |
| DDC1 | Double door classic | 1425 | 1955 | 1 |
| DCB6 | Door crossbar 6 | -- | -- | 2 |

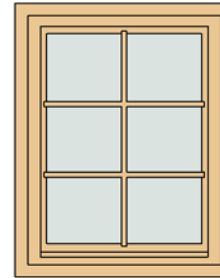

| Window Schedule | | | | |
|-----------------|-----------------------|-------|--------|-------|
| Mark | Type | Width | Height | Count |
| SWC1 | Single window classic | | | 1 |
| WCB6 | Window crossbar 6 | -- | -- | 1 |

| Fasteners/Extras | | |
|------------------|------|-------|
| Name | Type | Count |

| | | |
|----------|------------|-----|
| Hitblock | 300-400 mm | |
| Bolts | M8 x 60 | 12 |
| Screws | 5,0 x 70 | 15 |
| Screws | 6,0 x 140 | 40 |
| Screws | 4,0 x 40 | 110 |
| Screws | 4,0 x 50 | 750 |



| Type | Count | Lenght |
|-----------------|-------|--------|
| Windboard 18x38 | 4 | 2010 |



| Family | Count |
|--------|-------|
| Romb | 2 |

Brantevik II 40

List of all items 1

Impregnated foundation beams

| Mark | Type | Profile | Count | Length |
|------|------|---------|-------|--------|
|------|------|---------|-------|--------|

| | | | | |
|-----|-----------|---|---|------|
| IFB | IFB 45x70 |  | 7 | 3600 |
|-----|-----------|---|---|------|

Floor Schedule

| Mark | Type | Profile | Count | Length |
|------|------|---------|-------|--------|
|------|------|---------|-------|--------|

| | | | | |
|----|-----------|---|----|------|
| FB | FB 18x110 |  | 33 | 3515 |
|----|-----------|---|----|------|

| | | | | |
|----|----------|---|----|--------|
| BB | BB 20x40 |  | -- | 14,1 m |
|----|----------|---|----|--------|

Roof

| Mark | Type | Profile | Count | Length |
|------|------|---------|-------|--------|
|------|------|---------|-------|--------|

| | | | | |
|-----|--------------|---|---|------|
| RFR | Ridge 40x143 |  | 1 | 5100 |
|-----|--------------|---|---|------|

| | | | | |
|-----|-------------|---|---|------|
| RFB | Beam 40x143 |  | 2 | 5100 |
|-----|-------------|---|---|------|

| | | | | |
|----|------------------|---|----|------|
| RB | Roofboard 18x110 |  | 94 | 2195 |
|----|------------------|---|----|------|

Fascia Schedule

| Mark | Type | Profile | Count | Length |
|------|------|---------|-------|--------|
|------|------|---------|-------|--------|

| | | | | |
|----|-------------------|---|---|------|
| EE | Eave Edging 18x90 |  | 4 | 2233 |
|----|-------------------|---|---|------|

| | | | | |
|----|-------------------|---|---|------|
| RF | Roof Fascia 18x90 |  | 4 | 2233 |
|----|-------------------|---|---|------|

| | | | | |
|-----|--------------------------|---|---|------|
| RR1 | Roof reinforcement 18x90 |  | 2 | 5100 |
|-----|--------------------------|---|---|------|

| | | | | |
|-----|--------------------------|---|---|------|
| RR2 | Roof reinforcement 28x28 |  | 4 | 2550 |
|-----|--------------------------|---|---|------|

Brantevik II 40

List of all items 2

| Wall 1 | | | | |
|--------|-------------|---------|-------|------------|
| Mark | FM SortMark | Profile | Count | Cut Length |

| | | | | |
|--------|------|--------|----|------|
| 1BL 1 | BL 1 | 40X57 | 1 | 575 |
| 1BL 2 | BL 2 | 40X57 | 1 | 1785 |
| 1LG 1 | LG 1 | 40X114 | 9 | 440 |
| 1LG 2 | LG 2 | 40X114 | 26 | 575 |
| 1LG 3* | LG 3 | 40X114 | 1 | 3800 |
| 1LG 4* | LG 4 | 40X114 | 1 | 796 |
| 1LG 5* | LG 5 | 40X114 | 1 | 1591 |
| 1LG 6 | LG 6 | 40X114 | 8 | 1785 |
| 1LG 7* | LG 7 | 40X114 | 1 | 2386 |
| 1LG 8* | LG 8 | 40X114 | 1 | 3182 |

| Wall 2 | | | | |
|--------|-------------|---------|-------|------------|
| Mark | FM SortMark | Profile | Count | Cut Length |

| | | | | |
|--------|------|--------|----|------|
| 2BL 1 | BL 1 | 40X57 | 1 | 3800 |
| 2LG 1* | LG 1 | 40X114 | 1 | 796 |
| 2LG 2* | LG 2 | 40X114 | 1 | 1591 |
| 2LG 3 | LG 3 | 40X114 | 1 | 2386 |
| 2LG 4* | LG 4 | 40X114 | 1 | 3182 |
| 2LG 5* | LG 5 | 40X114 | 1 | 3800 |
| 2LG 6* | LG 6 | 40X114 | 17 | 3800 |

*Gable-delivered premounted



| Wall A | | | | |
|--------|-------------|---------|-------|------------|
| Mark | FM SortMark | Profile | Count | Cut Length |

| | | | | |
|-------|------|--------|----|------|
| ALG 1 | LG 1 | 40X114 | 14 | 3800 |
| ALG 2 | LG 2 | 40X114 | 1 | 4100 |
| ALG 3 | LG 3 | 40X114 | 1 | 4400 |
| ALG 4 | LG 4 | 40X114 | 1 | 4700 |
| ATL 1 | TL 1 | 40X120 | 1 | 5100 |

| Wall B | | | | |
|--------|-------------|---------|-------|------------|
| Mark | FM SortMark | Profile | Count | Cut Length |

| | | | | |
|-------|------|--------|----|------|
| BLG 1 | LG 1 | 40X114 | 14 | 3800 |
| BLG 2 | LG 2 | 40X114 | 1 | 4100 |
| BLG 3 | LG 3 | 40X114 | 1 | 4400 |
| BLG 4 | LG 4 | 40X114 | 1 | 4700 |
| BTL 1 | TL 1 | 40X120 | 1 | 5100 |

| Log Profiles | |
|--------------|---------|
| Profile | Profile |

| | |
|--------|---|
| 40X57 |  |
| 40X114 |  |

| Log Profiles | |
|--------------|---------|
| Profile | Profile |

| | |
|--------|---|
| 40X120 |  |
|--------|---|