

Techn. Data: Bunkie

Log length (W x D): 290 x 380 cm

Wall size(outside): 270 x 360 cm · Log thickness: 40 mm

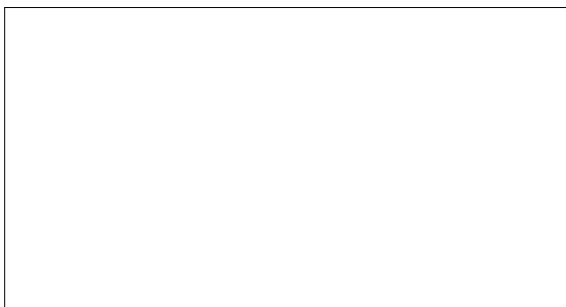

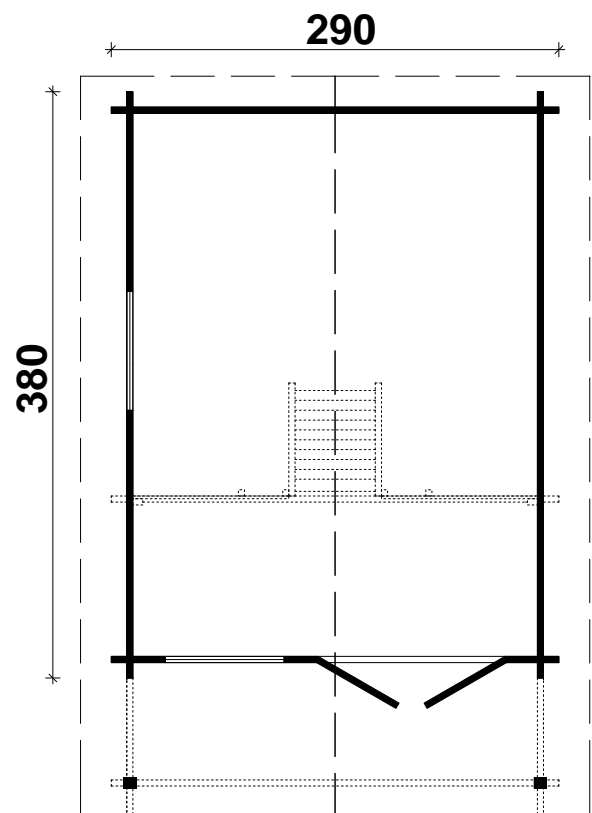













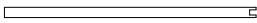

Note: All dimensions are approximate !

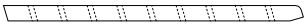
Specification - Bunkie 40 mm / 290 x 380 cm

Nr.	Description	Profile mm	Length mm	Quantity
001	Foundation beams		2690	2
002			3450	6
003			1340	1
004			350	1
005			2900	1
006			2900	2
007			2900	21
008			3800	25
009			1735	9
010			1340	8
011			1295	9
012			350	26
013			220	9
014			4700	2
015			4800	2
016/01			2900	2
016/02			2834	2
016/03			2551	2
016/04			2267	2
016/05			1984	2
016/06			161	4
016/07		1270	2	
016/08		1417	2	
016/09		1134	2	
016/10		850	2	
016/11		567	2	
016/12		115	4	
017			4800	2(1+1)
018			2900	2
019		68 x 143	4800	1
020		68 x 198	4800	2
021	Double door ca. 1200 x 1955mm - 40 mm			1
022	Window ca. 765 x 990 mm - 40 mm			2
023	Floor board		2617	32+1
024			1850	24
025	Baseboard		ca. 26,0 m	
026	Beam	40 x 90	2620	1
027	Roof board		2120	88+2

Specification - Bunkie 40 mm / 290 x 380 cm

Nr.	Description	Profile mm	Length mm	Quantity
028	Facia board 		2170	4
029	Eave edging		2170	4
030	Roof edge reinforcement		4800	2
031	Roof edge reinforcement		4800	2
032	Diamond			2
033	Storm braces 		2150	4
034	Storm braces 		710	4
035	Post 		1965	2
036	Adjustable postfoot			2
037	Ladder 		2318	2
038	Ladder		520	9
039	Fence		680	6
040	Fence		965	2
041	Fence		740	2
042	Trim		--	--
043	Trim		--	--
044	Bolt M 8 x 70, nut, washer			20
045	Nails 1,4 x 35			75
046	Ladder fittings 			2(1+1)
047	Screws 4,0 x 40 ; 4,0 x 50 ; 5,0 x 70 ; 6,0 x 140		170/600/20/100	
048	Hit block		300-400	

Bunkie 40 mm / 290 x 380 cm

Foundation beams

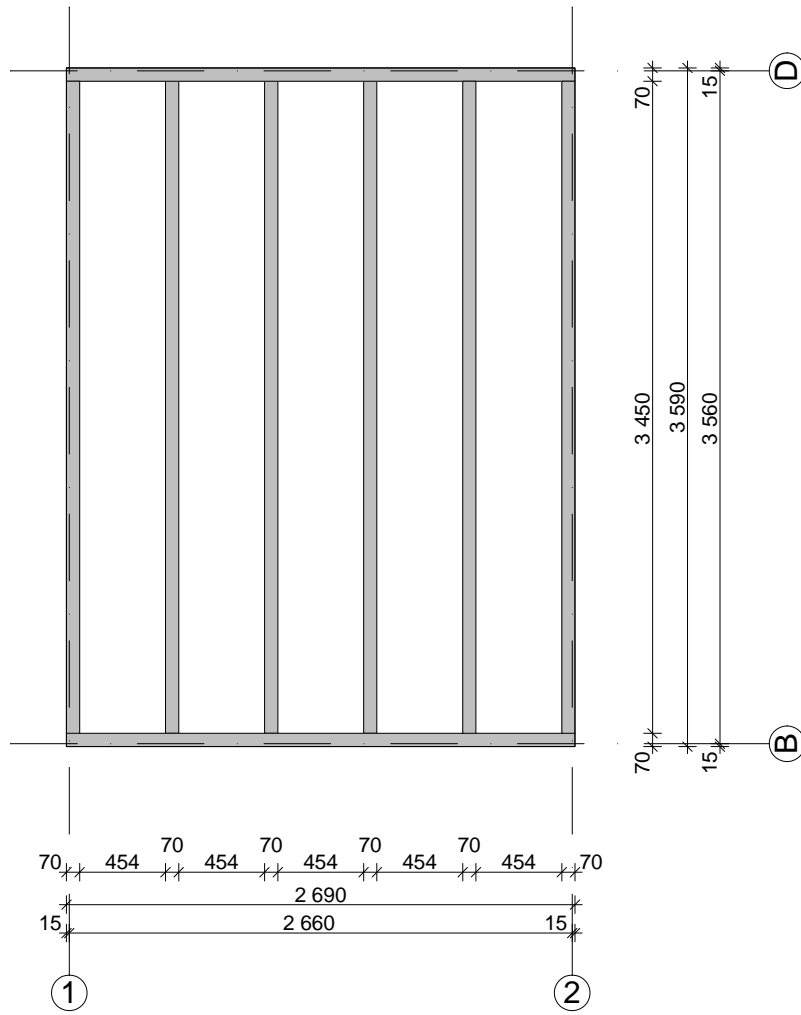

Bunkie 40 mm / 290 x 380 cm

Walls

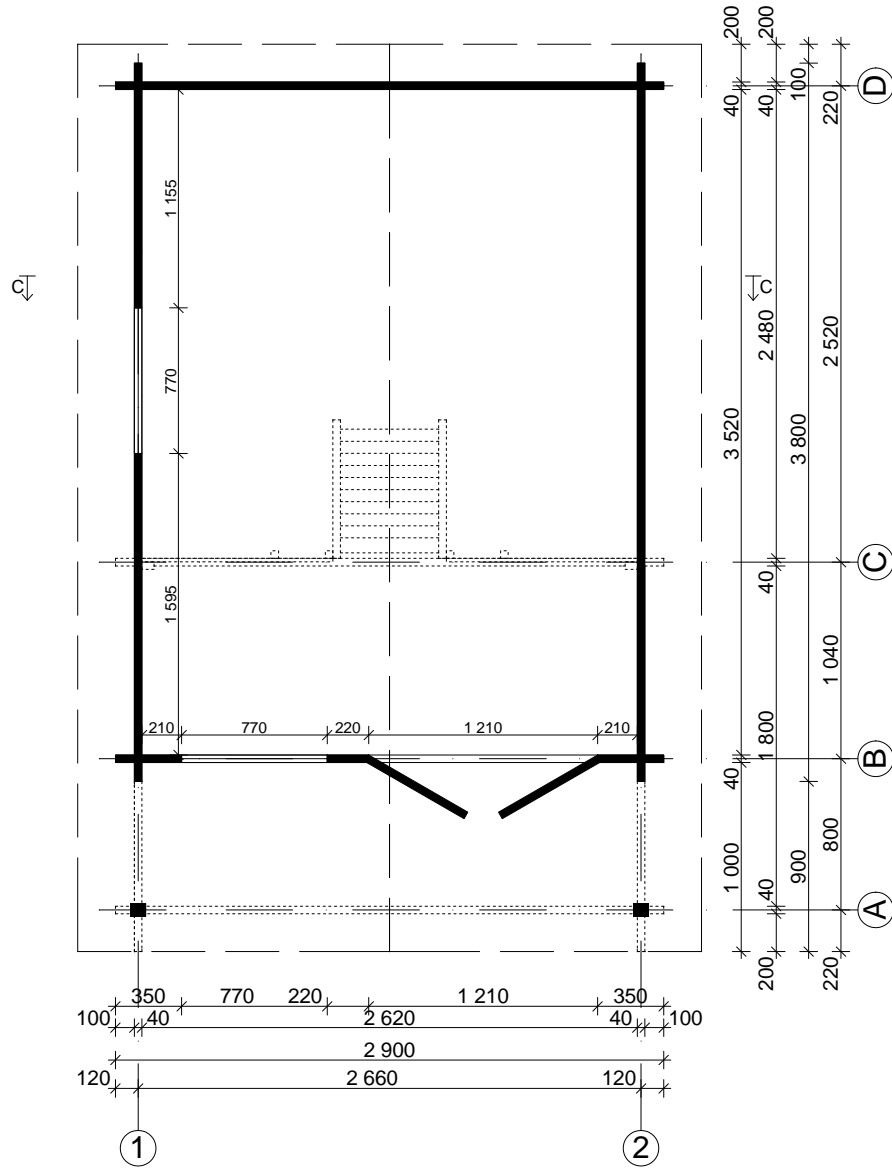

Bunkie 40 mm / 290 x 380 cm

A

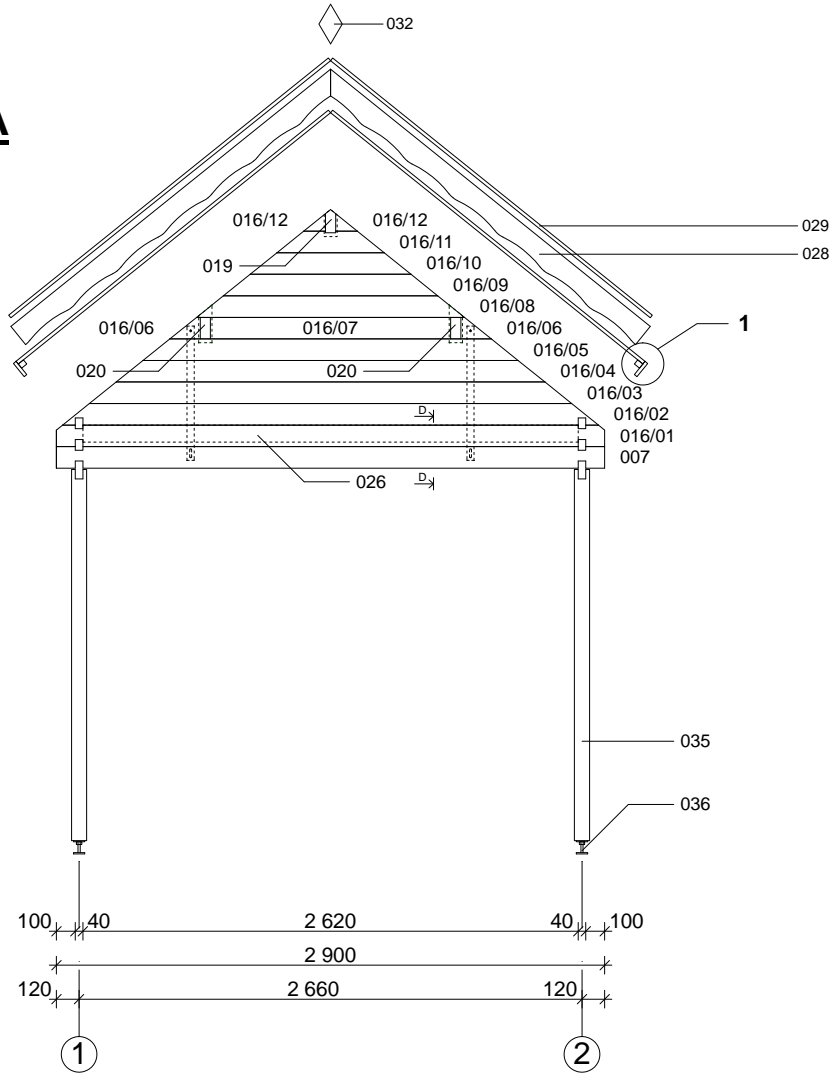

B

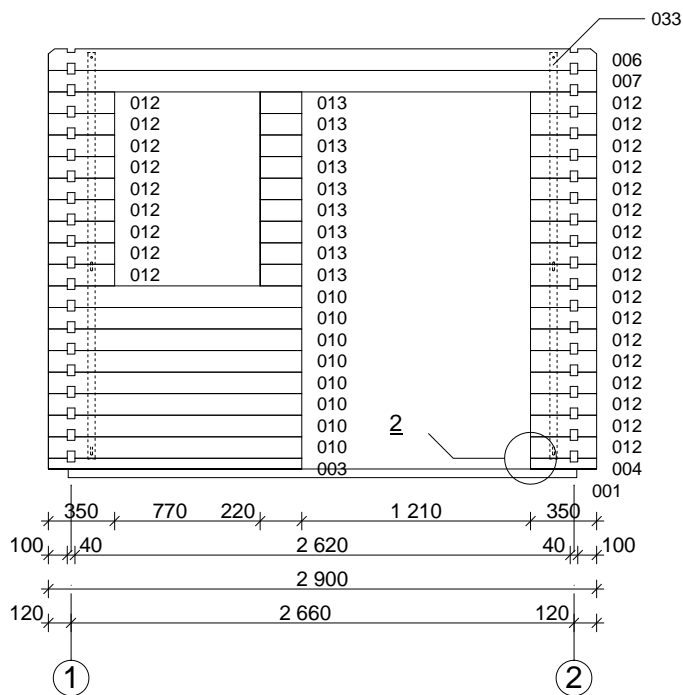

Bunkie 40 mm / 290 x 380 cm

C - C

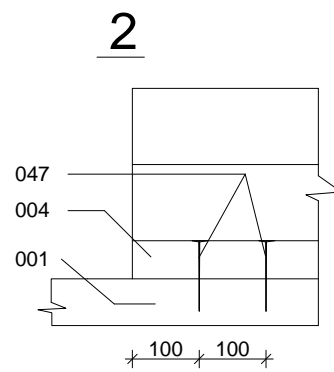
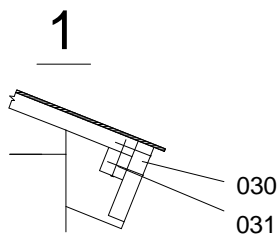
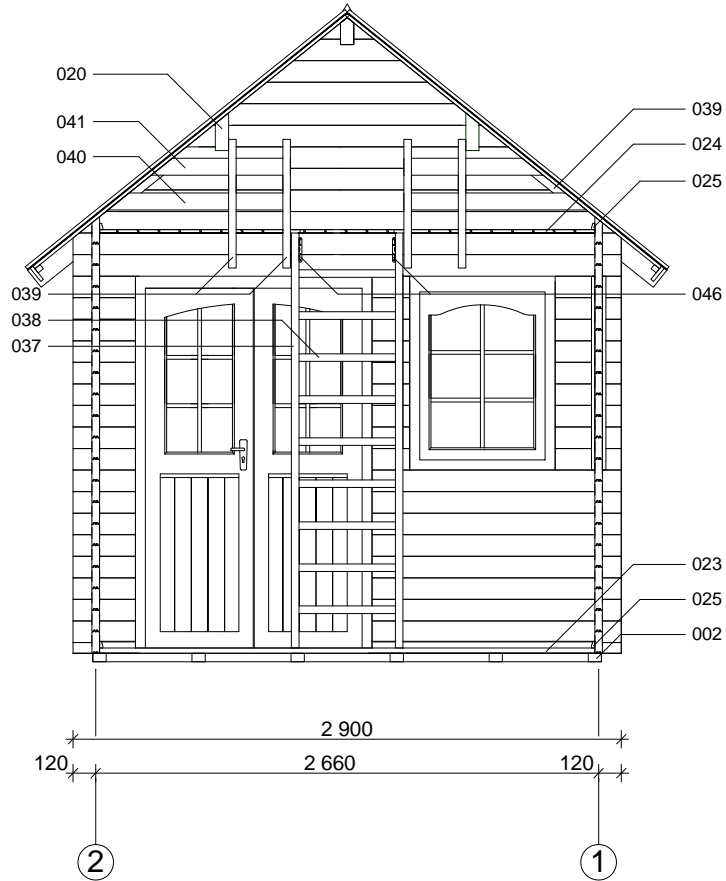

A-A

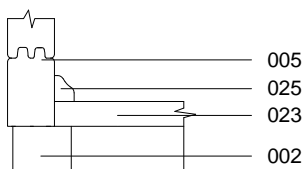

B-B

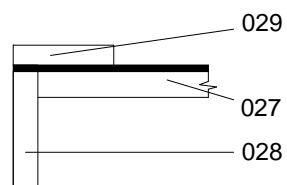

D-D

